

100% Money Back
Guarantee

Vendor:HP

Exam Code:HP2-T25

Exam Name:Servicing HP Rack-Tower Server
Solutions

Version:Demo

QUESTION 1

While installing an R7000 UPS, an engineer is asked to mount a ground bonding wire to the R7000. Referring to the exhibit, what is the intended ground wire connection point?

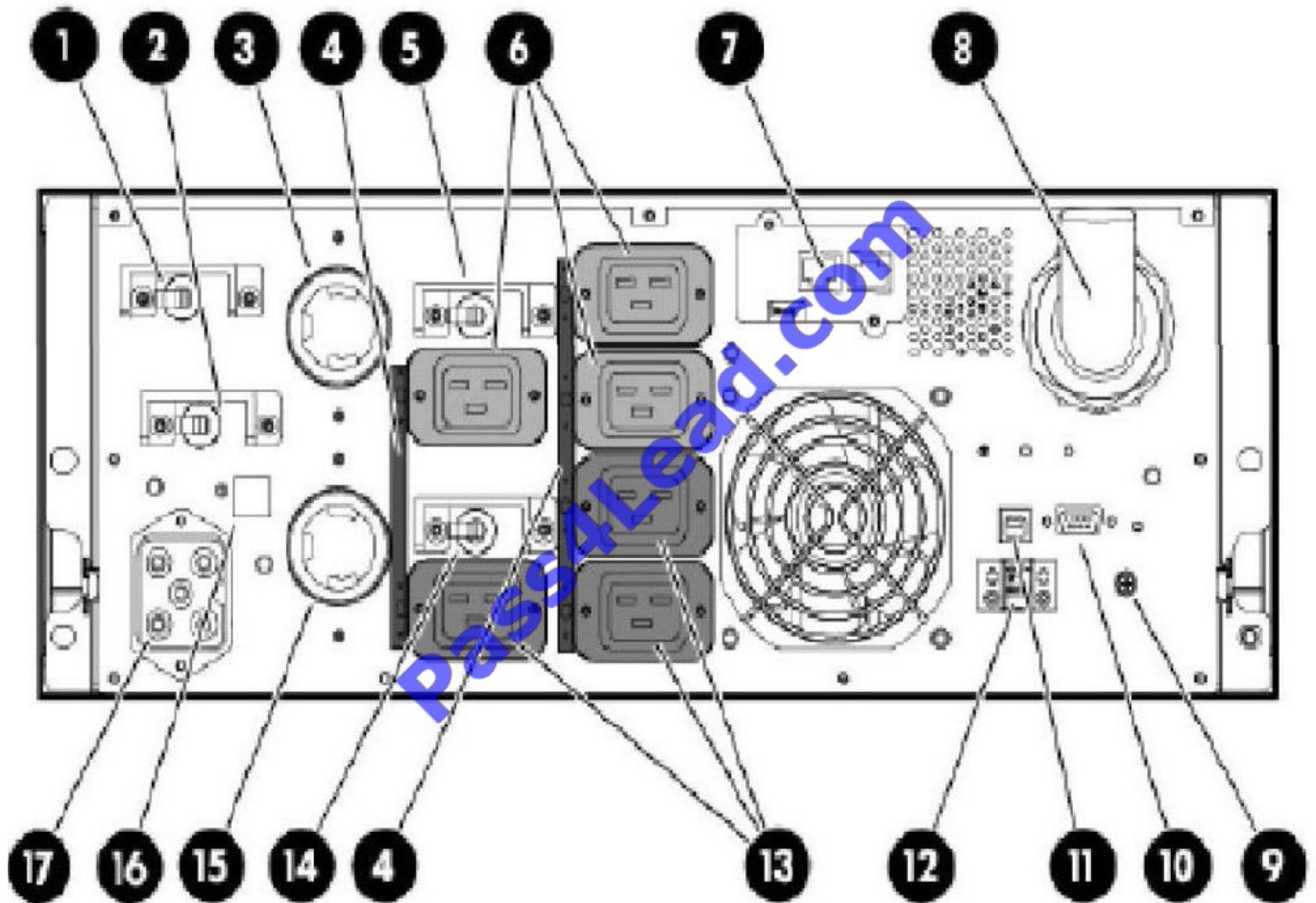

- A. item 7
- B. item 9
- C. item 10
- D. item 11
- E. item 12
- F. item 16

Correct Answer: B

Rear View:

1.

Load segment 1 circuit breaker (controls L6-30R receptacle Item 3)

2.
Load segment 2 circuit breaker (controls L6-30R receptacle Item 15)
3.
Large output NEMA L6-30R receptacle or IEC-60309 32A receptacle on short cords associated with load segment 1
4.
Cord retention clip attachment locations
5.
Load segment 1 circuit breaker (controls the C19 receptacles, but does not control the large output receptacle)
6.
3 x IEC C19 receptacles on load segment 1
7.
HP UPS Network Module
8.
Input power line cord with NEMA CS8265C plug or IEC- 309-32A plug
9.
Ground bonding screw
10.
Serial communications port
11.
USB communications port
12.
REPO port
13.
3 x IEC C19 receptacles on load segment 2

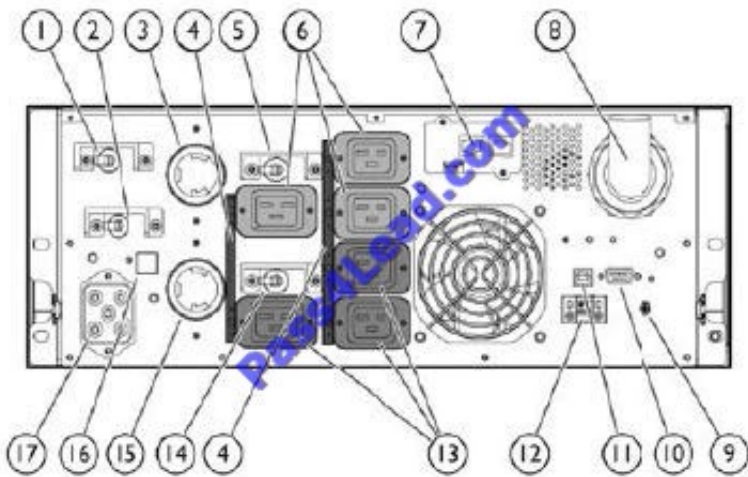

QUESTION 2

Match the correct UPS description with each picture.

Hot Area:

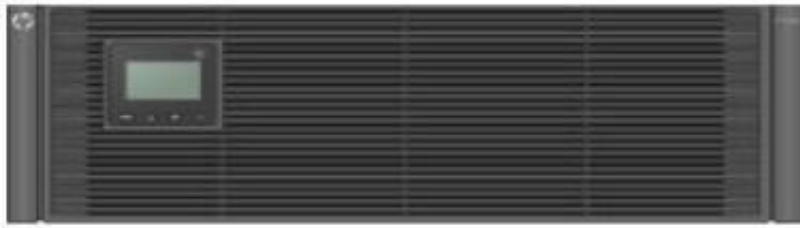

R7000
RP36000/3
R8000/3
R/T2200 G2
R1500 G3
R5500
T1000 G3



R7000
RP36000/3
R8000/3
R/T2200 G2
R1500 G3
R5500
T1000 G3



R7000
RP36000/3
R8000/3
R/T2200 G2
R1500 G3
R5500
T1000 G3

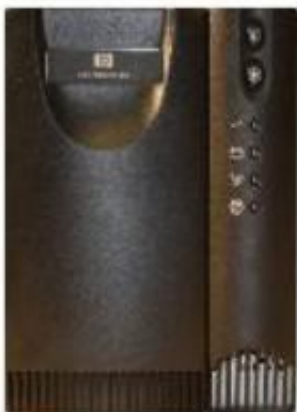

R7000
RP36000/3
R8000/3
R/T2200 G2
R1500 G3
R5500
T1000 G3

www.Pass4Lead.com

Hot Area:

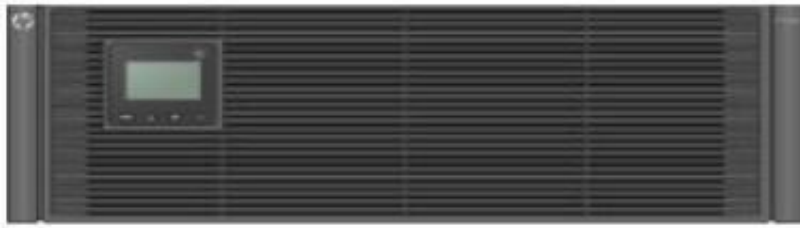

R7000
RP36000/3
R8000/3
R/T2200 G2
R1500 G3
R5500
T1000 G3



R7000
RP36000/3
R8000/3
R/T2200 G2
R1500 G3
R5500
T1000 G3



R7000
RP36000/3
R8000/3
R/T2200 G2
R1500 G3
R5500
T1000 G3

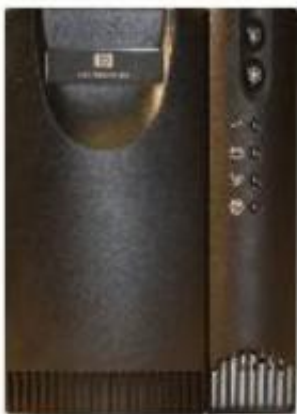

R7000
RP36000/3
R8000/3
R/T2200 G2
R1500 G3
R5500
T1000 G3

www.Pass4Lead.com

Correct Answer:

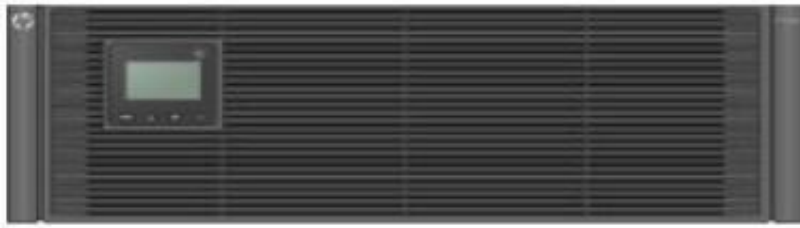

R7000
RP36000/3
R8000/3
R/T2200 G2
R1500 G3
R5500
T1000 G3



R7000
RP36000/3
R8000/3
R/T2200 G2
R1500 G3
R5500
T1000 G3



R7000
RP36000/3
R8000/3
R/T2200 G2
R1500 G3
R5500
T1000 G3



R7000
RP36000/3
R8000/3
R/T2200 G2
R1500 G3
R5500
T1000 G3

www.Pass4Lead.com

QUESTION 3

How do you enter the RBSU on Post?

- A. F8
- B. F9
- C. F11
- D. F12

Correct Answer: B

Tuning procedures Tuning with the ROM-based Setup Utility To configure BIOS low-latency options using RBSU:

1.

Boot the server.

2.

When prompted during POST, press F9 to enter RBSU.

3.

When the RBSU menu appears, press CTRL-A to display the option for the Service Options menu.

4.

Browse through the menus to change the parameters.

QUESTION 4

Which RAID level is known as Advance Data Guarding (ADG)?

- A. RAID 1
- B. RAID 5
- C. RAID 6
- D. RAID 10

Correct Answer: C

RAID 6 with HPs patented Advanced Data Guarding (ADG) technology is a cost-effective solution for storing large volumes of enterprise data with fault tolerance. Its performance, like that of other RAID levels, depends on the nature of the application. Organizations implementing a large drive array should consider RAID 6 because it can tolerate up to two simultaneous drive failures without downtime or data loss.

QUESTION 5

A support engineer is attending a call out for a DL360P Gen8 Server, where a hard disk within a four disk RAID 5 set has failed. The engineer notices that on three of the drives, the LED labeled D on the exhibit is on.

What does the condition indicate?

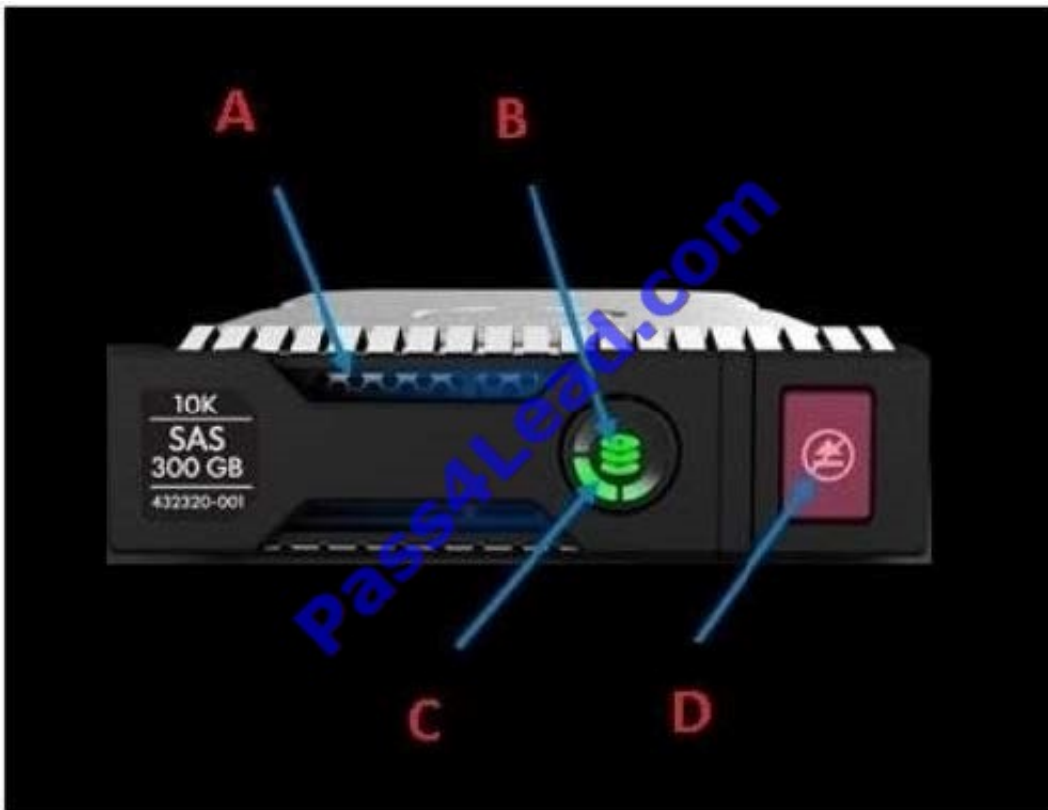

- A. Hot swapping of the failed drive is not supported in this condition.
- B. The LED indicates both failure and predictive failure alerts; therefore, two additional drives in the RAID set are at risk of failing and need to be replaced.
- C. The drive failure has corrupted three drives in the RAID set. The array will need to be rebuilt and data restored from backup.
- D. Do not remove the drives with this LED on.

Correct Answer: D

Drive LED definitions

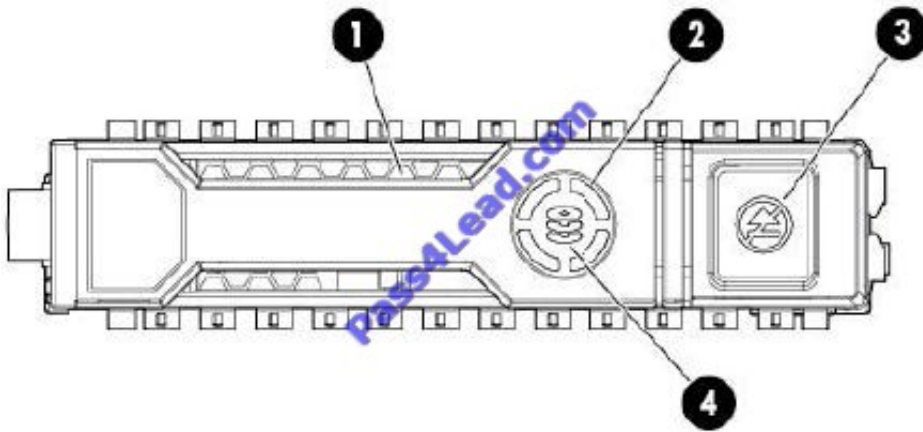

* Do not remove / Solid white Do not remove the drive. Removing the drive causes one or more of the logical drives to fail. / Off Removing the drive does not cause a logical drive to fail.

QUESTION 6

Which tool is used to identify correctable memory errors on a ProLiant Gen8 server that has an operating system without HP management agents installed?

- A. ACU
- B. System Management Home Page
- C. iLO
- D. HP SUM
- E. Active Health System

Correct Answer: C

The HP iLO3 management processor sends an alert to the server's administrator when a DIMM exceeds a predefined threshold for correctable memory errors or experiences an uncorrectable memory error. The administrator can view a log of correctable and uncorrectable memory error events through the Integrated Management Log (IML)

QUESTION 7

What must you consider when installing redundant fans?

- A. Locate the fans as specified in the server's documentation.
- B. Locate redundant fans on the side of the CPU.
- C. Locate the fans on the memory side.
- D. Place redundant fans in any location.

Correct Answer: A

Note:

* Example:

HP Support document

ProLiant DL380 G3 - Configuring the System Fans

You must observe the following requirements when installing redundant hot-plug fans:

To ensure optimum cooling, populate the primary fan locations, 2, 4, 5, 6, and 7, before populating the redundant locations.

If a primary fan fails, replace the non functioning fan before installing fans in redundant locations.

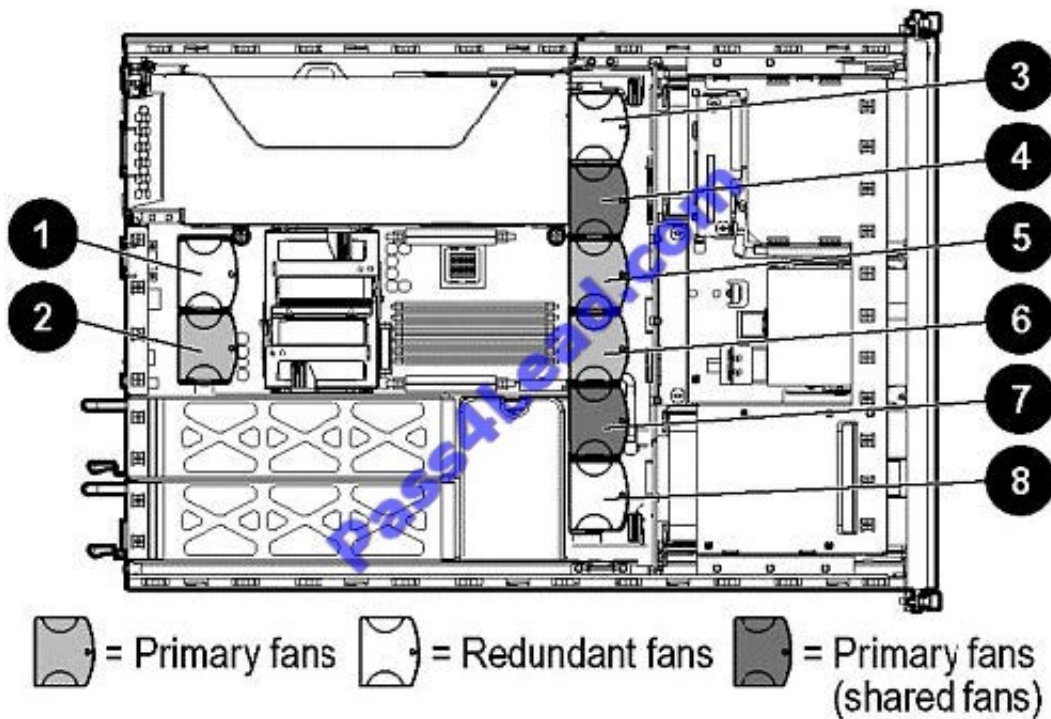

QUESTION 8

You replaced a system board on an HP Integrity rx2800 i2 Server. Which iLO command menu option is used to re-enable network connection options, such as telnet and Web SSL?

- A. SA: Set MP Access
- B. LS: LAN Security
- C. SO: Security Options
- D. LC: LAN Configuration

Correct Answer: D

Configuring the iLO 3 MP LAN using the RS-232 serial port:

The following procedure shows how to configure the iLO 3 MP LAN using the RS-232 serial port See step 6) below.

To assign a static IP address using the LC command, follow these steps:

QUESTION 9

What is achieved on ProLiant Gen8 Servers by including temperature sensors on stand-up components within the server (3D Sea of Sensors)?

- A. Cooling fans on stand-up components only run at 50% utilization.
- B. It provides more precise and more efficient cooling.
- C. It requires half the number of fans than in previous server models.
- D. Dedicated cooling fans are included on all stand-up components.

Correct Answer: B

HP Sea of Sensors 3D Introduced with ProLiant G6 servers, HP Sea of Sensors provides the data to precisely control the server fans and directly cool specific components, while not overcooling other components. This can reduce fan power consumption up to dozens of watts per server. HP Sea of Sensors 3D in ProLiant Gen8 servers extends the use of sensors to select PCI Express option cards, FlexibleNetwork Adapters, and FlexFabric Adapters to get a three-dimensional temperature profile in the server. This additional data enables more precise and efficient cooling of ProLiant Gen8 servers. The data is included in the always-on diagnostic information of the HP Active Health System.

QUESTION 10

A processor failed and was replaced in an HP Integrity rx2800 i2 server. Which UEFI command should be used to verify that the new processor is active and, if needed, may be used to activate it?

- A. cpuconfig
- B. info cpu
- C. activate cpu
- D. dump fru

Correct Answer: A

After replacing the processor and heat sink module use the cpuconfig from UEFI to verify the that the processor socket has been reconfigured.

QUESTION 11

A customer has an HP Smart Array P420i Zero Memory Controller and the current configuration has the minimum number of drives for RAID 1 and one hotspare.

What is the minimal requirement to upgrade it to RAID 5?

- A. One more hard disk
- B. One more hard disk with FBWC
- C. FBWC only
- D. Two more hard disks

Correct Answer: A

RAID 5 requires 3 hard drives, whereas RAID 1 requires only two. One extra hard drive is required here. Note:

*

Flash Backed Write Cache (FBWC).

*

RAID5 is available on the SA P420/P420i with a minimum of 512MB cache.

Incorrect:

Not C:

RAID 6 requirement: Minimum of 512 MB FBWC with SuperCap and Smart Array Advanced Pack License 2.0 key option upgrades

QUESTION 12

What is the best way to exercise replaced DAS components in a server?

- A. Run HP Insight Diagnostics online, selecting Diagnose.
- B. Run ADU.
- C. Run the hard disk test in BIOS.
- D. Run HP Insight Diagnostics offline, selecting Custom Test.

Correct Answer: D

* (not A) Using the Test tab (HP Insight Diagnostics Offline Edition only) *

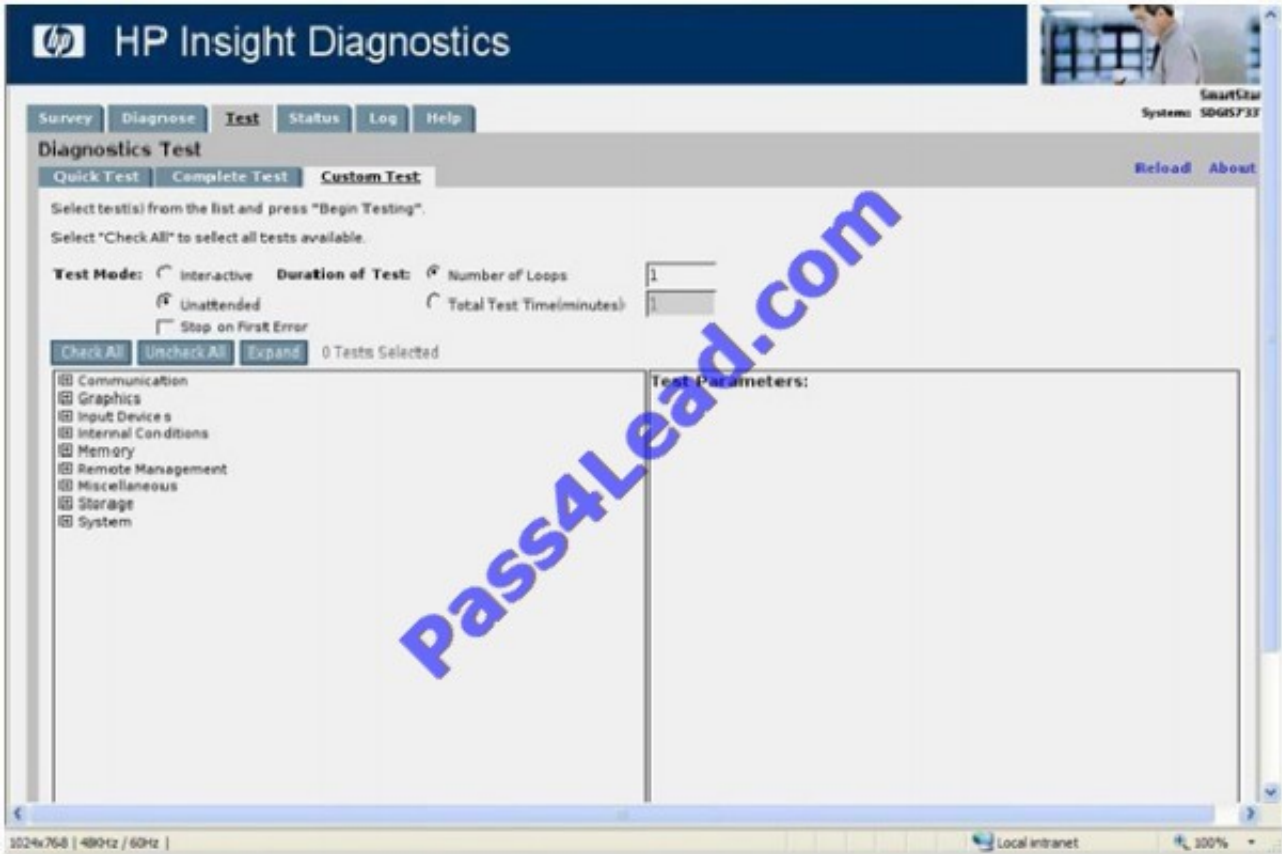

Note: direct attached storage (DAS) References:

To Read the [Whole Q&As](#), please purchase the [Complete Version](#) from [Our website](#).

Try our product !

100% Guaranteed Success

100% Money Back Guarantee

365 Days Free Update

Instant Download After Purchase

24x7 Customer Support

Average **99.9%** Success Rate

More than **800,000** Satisfied Customers Worldwide

Multi-Platform capabilities - **Windows, Mac, Android, iPhone, iPod, iPad, Kindle**

Need Help

Please provide as much detail as possible so we can best assist you.

To update a previously submitted ticket:



 <p>One Year Free Update Free update is available within One Year after your purchase. After One Year, you will get 50% discounts for updating. And we are proud to boast a 24/7 efficient Customer Support system via Email.</p>	 <p>Money Back Guarantee To ensure that you are spending on quality products, we provide 100% money back guarantee for 30 days from the date of purchase.</p>	 <p>Security & Privacy We respect customer privacy. We use McAfee's security service to provide you with utmost security for your personal information & peace of mind.</p>
---------------------------------------------------------------------------------------------------------------------------------------------------------------------------------------------------------------------------------------------------------------------------------------------------------------------------------	-------------------------------------------------------------------------------------------------------------------------------------------------------------------------------------------------------------------------------------------------------------	------------------------------------------------------------------------------------------------------------------------------------------------------------------------------------------------------------------------------------------------------------------------------------

Any charges made through this site will appear as Global Simulators Limited.

All trademarks are the property of their respective owners.